



shademaker[™]
architectural shade

2014



shademaker

By fusing the imagination of outdoor fashion with the practicalities of environmental performance, Shademaker represents "the apex of shade design". For more than a decade Shademaker has been the premier line of shade for the finest restaurants, resorts and country clubs around the world.



Shademaker offers a complete line of shade solutions, with many innovative styles and distinct configurations, Shademaker can help you create a sophisticated and functional environment in any setting.



Corona

Astral

Sirius

Nova

Orion

Galaxy

shademaker





corona





corona

The best selling style in the collection. The simple Corona style and single pole design is the ideal solution for all market style applications.

Available in:

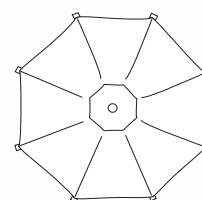
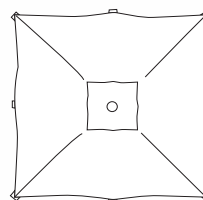

6' 6" Square

8' 2" Octagon

8' 2" Square

9' 9" Octagon

Finish: Silver Shadow

Mast Type: 1 1/2" Round Centerpost

Applications: Commercial and Residential

Wind Rating: 6 (based on Beaufort wind rating scale)



Item No.	Size		Canopy Shape	Coverage	Ribs	MSRP Price Group 1 <i>Sunbrella® Awning Grade</i>	MSRP Price Group 2 <i>O'bravia™ Awning Grade Sunbrella® Furniture Grade</i>	Min. Base Weight*
	meters	feet						
CORONA-20S	2.0m	6' 6"	Square	43 sq. ft.	4	\$725	\$563	100 lbs.
CORONA-25S	2.5m	8' 2"	Square	67 sq. ft.	8	\$888	\$727	100 lbs.
CORONA-25	2.5m	8' 2"	Octagon	52 sq. ft.	8	\$875	\$708	100 lbs.
CORONA-30	3.0m	9' 9"	Octagon	75 sq. ft.	8	\$1,050	\$850	150 lbs.

***NOTE: Recommended minimum weight requirements for free-standing applications.**

- Commercial awning and furniture grade fabric options
- Durable high performance hub and fittings
- Simple open/close stainless steel pulley system
- Fits in standard size umbrella bases
- Galvanized steel internal mast stem/powder coated base plate included
- Custom designed protective cover included
- See page 34 for concrete, wood deck and in-ground mounting options
See pages 35 & 38 for steel and cast aluminum bases

Visit www.shademakerusa.com for more details on sizes and specifications.



shademaker





astral



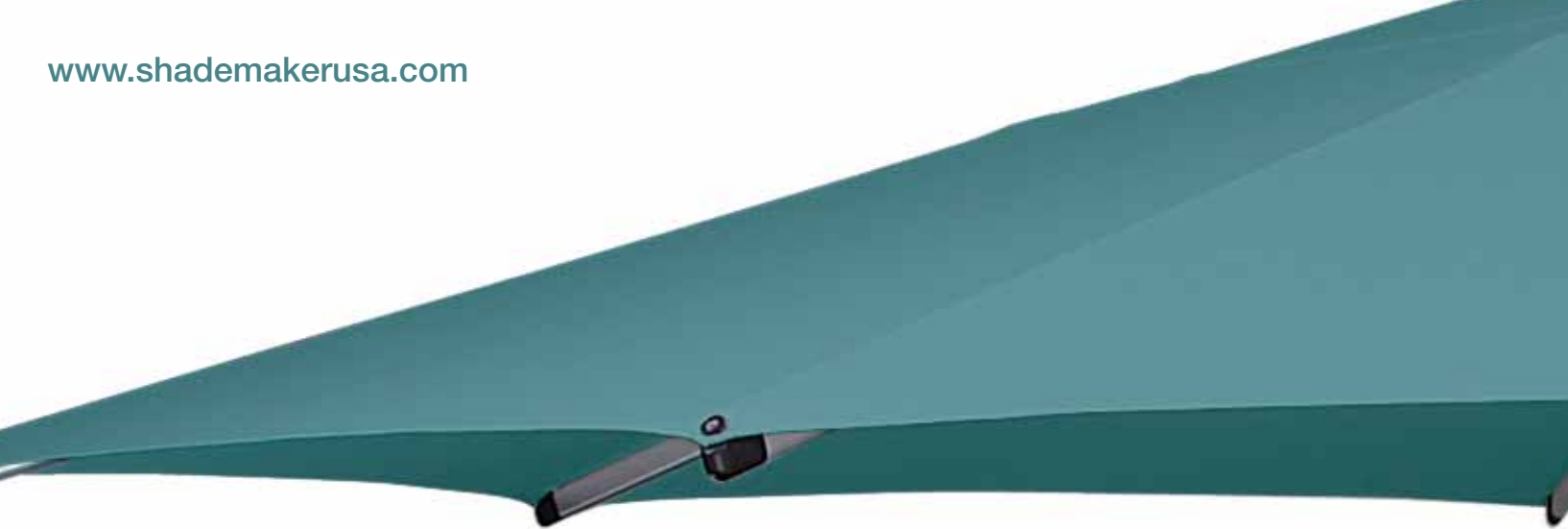

astral

The colossal giant of our centerpost styles. The Astral is a solid solution for exceptionally large spaces.



Available in:

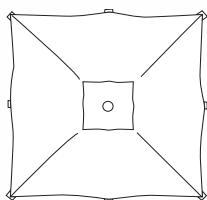

11' 5" Square

13' 1" Square

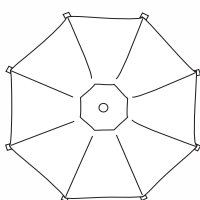

14' 8" Octagon

16' 4" Octagon

Finish: Silver Shadow

Mast Type: 3" Round Centerpost

Applications: Commercial

Wind Rating: 8 (based on Beaufort wind rating scale)



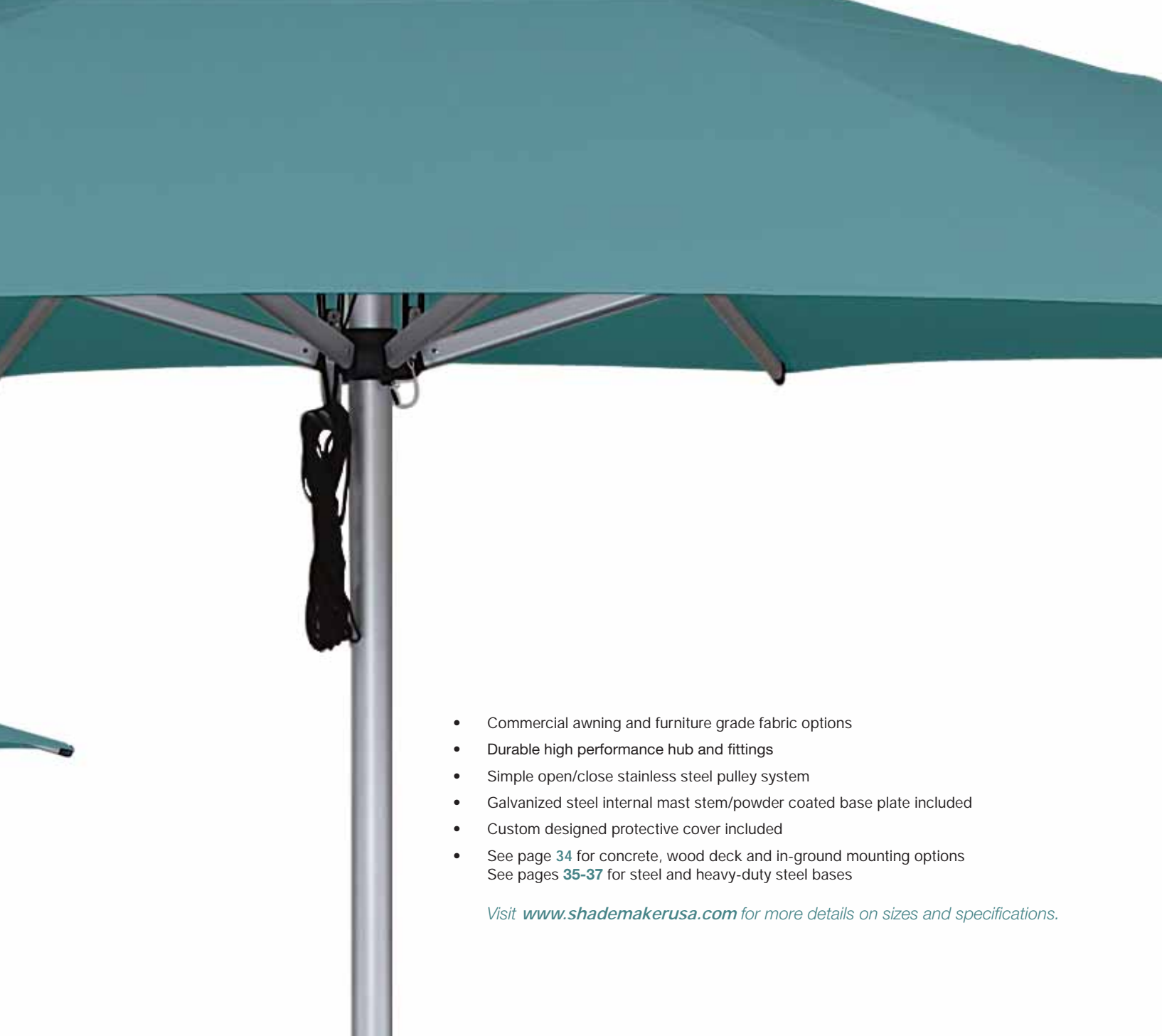

- Commercial awning and furniture grade fabric options
- Durable high performance hub and fittings
- Simple open/close stainless steel pulley system
- Galvanized steel internal mast stem/powder coated base plate included
- Custom designed protective cover included
- See page 34 for concrete, wood deck and in-ground mounting options
See pages 35-37 for steel and heavy-duty steel bases

Visit www.shademakerusa.com for more details on sizes and specifications.

Item No.	Size		Canopy Shape	Coverage	Ribs	MSRP Price Group 1 <i>Sunbrella® Awning Grade</i>	MSRP Price Group 2 <i>O'bravia™ Awning Grade Sunbrella® Furniture Grade</i>	Min. Base Weight*
	meters	feet						
ASTRAL-35S	3.5m	11' 5"	Square	131 sq. ft.	8	\$4,260	\$3,410	350 lbs.
ASTRAL-40S	4.0m	13' 1"	Square	172 sq. ft.	8	\$4,905	\$3,930	400 lbs.
ASTRAL-45	4.5m	14' 8"	Octagon	201 sq. ft.	8	\$4,625	\$3,700	**
ASTRAL-50	5.0m	16' 4"	Octagon	210 sq. ft.	8	\$5,140	\$4,115	**

***NOTE: Recommended minimum weight requirements for free-standing applications.**

*** Please contact your Sales Representative for free-standing base option recommendations for ASTRAL-45 and ASTRAL-50.*

shademaker™





nova

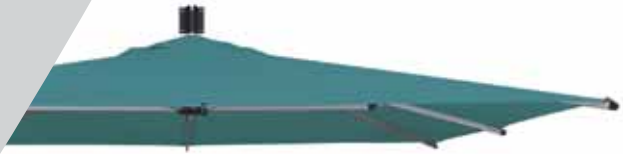

nova

nova

The innovative and unique beam mount design of the Nova is the ideal solution for pergolas and existing structures. The canopy structure easily detaches for storage.



Item No.	Size		Canopy Shape	Coverage	Ribs	MSRP Price Group 1	MSRP Price Group 2
	meters	feet				Sunbrella® Awning Grade	O'bravia™ Awning Grade Sunbrella® Furniture Grade
NV-27S	2.7m	8' 9"	Square	77 sq. ft.	8	\$995	\$830

Canopy structure easily detaches for storage

- Commercial awning and furniture grade fabric options
- Durable high performance hub and fittings
- Simple to operate lift system
- Custom designed protective cover included

Visit www.shademakerusa.com for more details on sizes and specifications.

Available in:

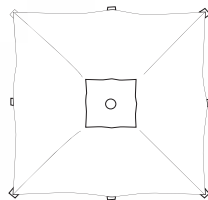

8' 9" Square

Finish: Silver Shadow



Mast Type: Beam Mount

Applications: Commercial and Residential

Wind Rating: 6 (based on Beaufort wind rating scale)

shademaker™





sirius



sirius

Introduced in 1998, the Sirius is the original Shademaker design. This innovative design rotates 360° and tilts. When not in use, the Sirius folds back to the mast in a clean, compact manner.

The perfect solution for residential pools, spas, patios and decks.

Use of the Mount Kits provide substantial cost savings and creates the preferred small footprint.

- Commercial awning and furniture grade fabric options
- Durable high performance hub and fittings
- Stainless steel hardware for longevity
- Elegant and simple to operate tilt system
- Galvanized steel internal mast stem/powder coated base plate included
- Custom designed protective cover included
- See page 34 for concrete, wood deck and in-ground mounting options
- See pages 35-37 for steel and heavy-duty steel bases

Visit www.shademakerusa.com for more details on sizes and specifications.



360° rotation



tilt



small footprint



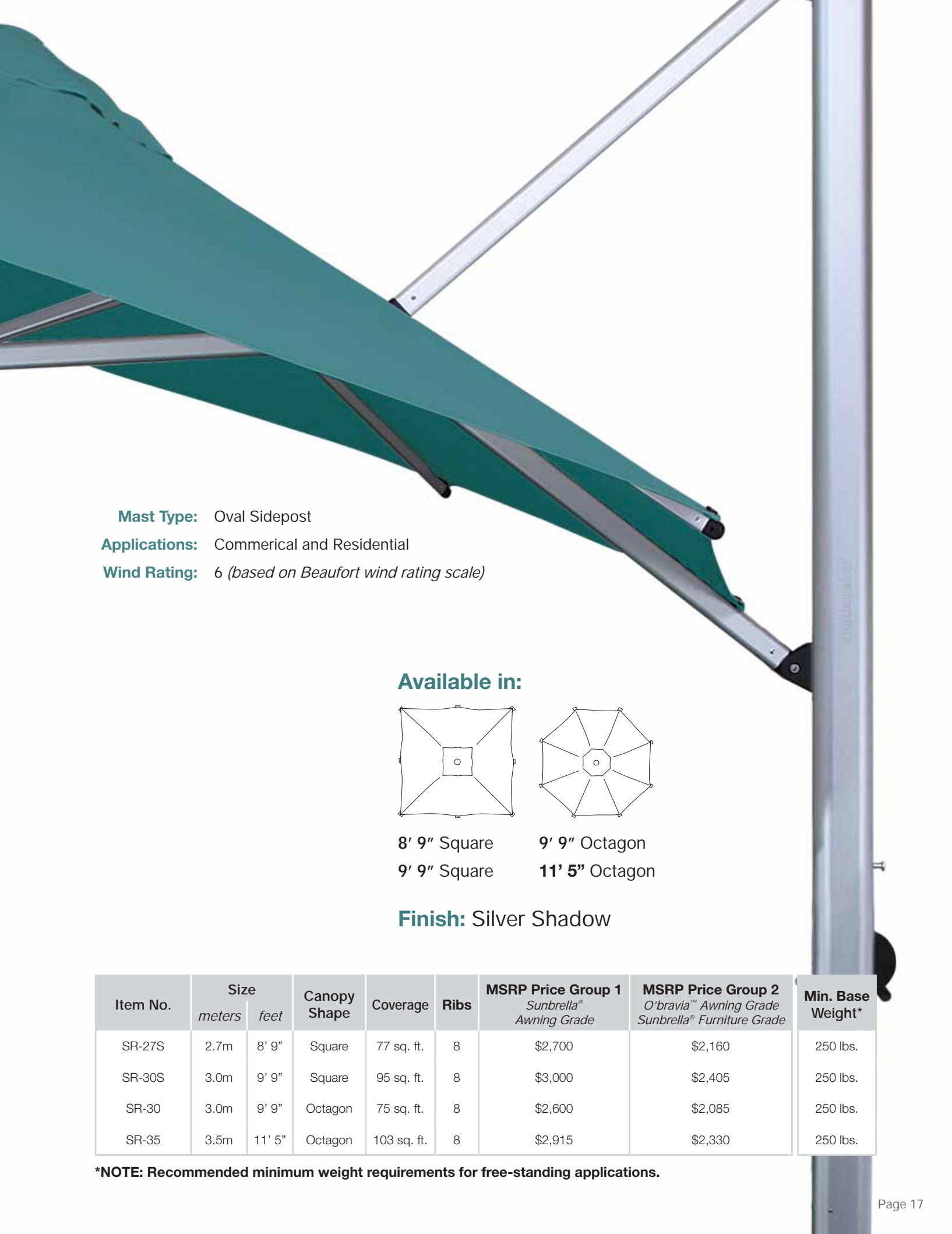

Mast Type: Oval Sidepost
Applications: Commercial and Residential
Wind Rating: 6 (based on Beaufort wind rating scale)

Available in:

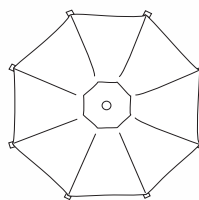
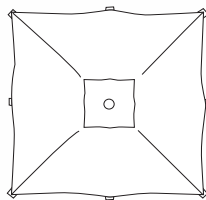

8' 9" Square
 9' 9" Square

9' 9" Octagon
 11' 5" Octagon

Finish: Silver Shadow

Item No.	Size		Canopy Shape	Coverage	Ribs	MSRP Price Group 1 <i>Sunbrella® Awning Grade</i>	MSRP Price Group 2 <i>O'bravia™ Awning Grade Sunbrella® Furniture Grade</i>	Min. Base Weight*
	meters	feet						
SR-27S	2.7m	8' 9"	Square	77 sq. ft.	8	\$2,700	\$2,160	250 lbs.
SR-30S	3.0m	9' 9"	Square	95 sq. ft.	8	\$3,000	\$2,405	250 lbs.
SR-30	3.0m	9' 9"	Octagon	75 sq. ft.	8	\$2,600	\$2,085	250 lbs.
SR-35	3.5m	11' 5"	Octagon	103 sq. ft.	8	\$2,915	\$2,330	250 lbs.

***NOTE:** Recommended minimum weight requirements for free-standing applications.

shademaker™





THE SHERATON
HOTEL

orion





orion

Our best selling sidepost style.

The ideal solution for most commercial applications. The Orion features 360° rotation. The canopy structure easily detaches for storage.

Use of the Mount Kits provide substantial cost savings and creates the preferred small footprint.

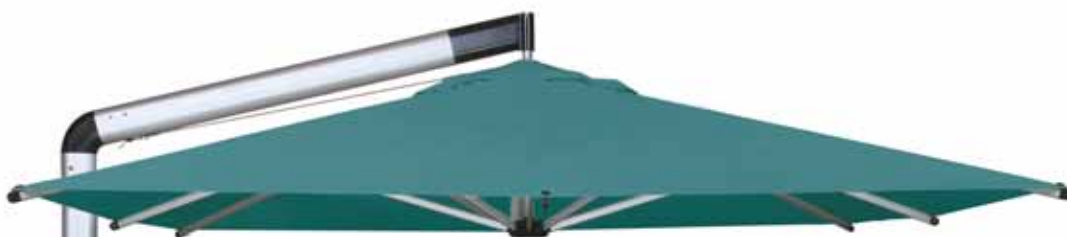

- Commercial awning and furniture grade fabric options
- Durable high performance hub and fittings
- High-grade stainless steel cable
- Elegant and simple to operate lift system
- Galvanized steel internal mast stem/powder coated base plate included
- Custom designed protective cover included
- See page 34 for concrete, wood deck and in-ground mounting options
See pages 35-37 for steel and heavy-duty steel bases

Visit www.shademakerusa.com for more details on sizes and specifications.



360° rotation

small footprint



Mast Type: Oval Sidepost
Applications: Commercial
Wind Rating: 6 (based on Beaufort wind rating scale)

Available in:

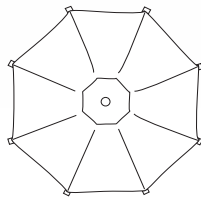
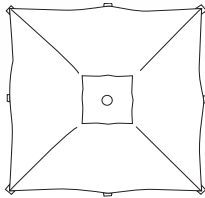

- 8' 9" Square
- 9' 9" Square
- 9' 9" Octagon
- 11' 5" Octagon
- 13' 1" Octagon

Finish: Silver Shadow

Canopy structure easily detaches for storage



Item No.	Size		Canopy Shape	Coverage	Ribs	MSRP Price Group 1 <i>Sunbrella® Awning Grade</i>	MSRP Price Group 2 <i>O'bravia™ Awning Grade Sunbrella® Furniture Grade</i>	Min. Base Weight*
	meters	feet						
OR-27S	2.7m	8' 9"	Square	77 sq. ft.	8	\$3,005	\$2,405	250 lbs.
OR-30S	3.0m	9' 9"	Square	95 sq. ft.	8	\$3,130	\$2,505	250 lbs.
OR-30	3.0m	9' 9"	Octagon	75 sq. ft.	8	\$2,985	\$2,385	250 lbs.
OR-35	3.5m	11' 5"	Octagon	103 sq. ft.	8	\$3,275	\$2,620	250 lbs.
OR-40	4.0m	13' 1"	Octagon	134 sq. ft.	8	\$3,590	\$2,875	400 lbs.

***NOTE: Recommended minimum weight for free-standing applications.**

shademaker™





galaxy



galaxy

Our Galaxy is the giant of all sidepost styles; superior in design, durability and size.

Available in:

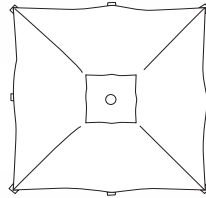

11' 5" Square

13' 1" Square

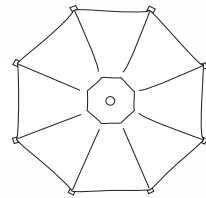

16' 4" Octagon



Finish: Silver Shadow



Item No.	Size		Canopy Shape	Coverage	Ribs	MSRP Price Group 1 <i>Sunbrella® Awning Grade</i>	MSRP Price Group 2 <i>O'bravia™ Awning Grade Sunbrella® Furniture Grade</i>
	meters	feet					
GALAXY-35S	3.5m	11' 5"	Square	131 sq. ft.	8	\$5,290	\$4,230
GALAXY-40S	4.0m	13' 1"	Square	172 sq. ft.	8	\$5,990	\$4,790
GALAXY-50	5.0m	16' 4"	Octagon	210 sq. ft.	8	\$6,310	\$5,045

Please contact your Sales Representative for mounting and base option recommendations.
A licensed contractor is recommended for installation and repositioning.

- Commercial awning and furniture grade fabric options
- Durable high performance hub and fittings
- High grade stainless steel cable
- Style can be repositioned
- Galvanized steel internal mast stem/powder coated base plate included
- Custom designed protective cover included
- See page 34 for concrete and in-ground mounting options
 See pages 36-37 for heavy-duty steel bases

Visit www.shademakerusa.com for more details on sizes and specifications.

Mast Type: Oval Sidepost

Applications: Commercial

Wind Rating: 8 (based on Beaufort wind rating scale)

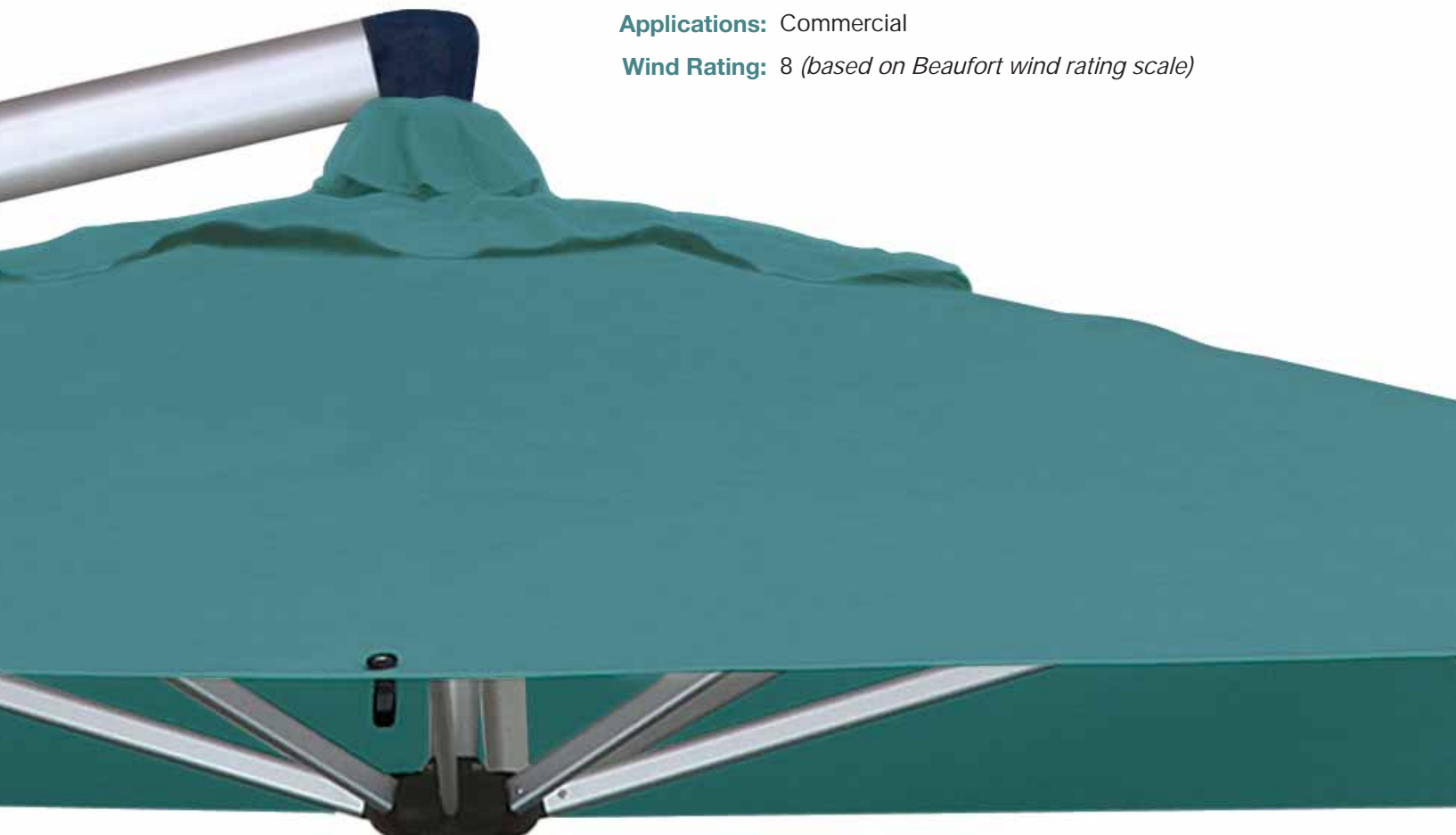

shademaker™





fabrics

Shademaker offers a complete line of fabric choices, from the finest mills in the world.

sunbrella®

o'bravia
AWNING

Price Group 1



All Sunbrella fabrics are easy to clean and fade resistant, you can be sure that your umbrellas will look beautiful for years and years.

- A premier performance fabric
- 10 year limited warranty
- Combination of durability and water repellency, breathability and beautiful style
- Fade-proof, stain-resistant and worry-free Sunbrella fabrics

100% Solution-Dyed Acrylic **Awning Grade Collection**

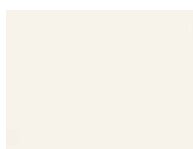

4604 Natural

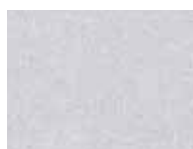

4651 Silver

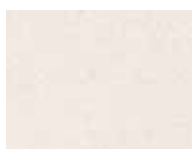

4642 Oyster

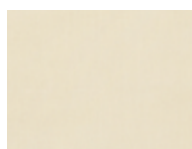

4683 Parchment



4633 Linen



4630 Cadet Grey



4676 Cocoa



4620 Beige



4648 Taupe



4644 Charcoal Grey



4674 Wheat



4635 Buttercup



4602 Sunflower Yellow



4609 Orange



4677 Tuscan



4689 Rust



4686 Nutmeg



4621 True Brown



4667 Mahogany



4622 Terracotta



4666 Logo Red



4603 Jockey Red



4631 Burgundy

fabric



100% Solution-Dyed Acrylic **Awning Grade Collection**



4608 Black

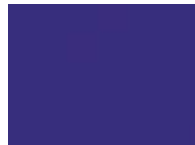

4665 Concord



4615 Smoke



4684 Slate



4626 Navy



4678 Marine Blue



4601 Pacific Blue



4679 Ocean Blue



4652 Mediterranean
Blue



4675 Capri



4624 Sky Blue



4673 Spa



4685 Ginkgo



4610 Turquoise



4612 Aruba



4623 Aquamarine



4643 Persian Green



4600 Erin Green



4645 Seagrass Green



4637 Forest Green



4695 Tresco Linen



4658 Tresco Brass

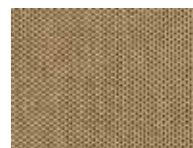

4696 Tresco Birch



4697 Tresco Ginger



4698 Tresco Clay



4699 Tresco Brick



4862S Silica Silver



4859S Silica Dune



4858S Silica Barley



4861S Silica Stone

Note: Fabric representation not to scale. Patterns, textures and colors may vary slightly from the actual fabric swatches; please refer to the Shademaker fabric swatch card for actual samples.

Price Group 2



The O'bravia™ Awning Fabric Collection is the finest solution for elegance, comfort, strength and sustainability. O'bravia offers an exciting and sophisticated selection of fashionable solids that will enhance any outdoor environment.

- Our Exclusive Collection
- Excellent colorfastness - backed with a 5 year warranty
- Superb strength and durability providing years of beauty and enjoyment
- Stain resistant fabric that can easily be cleaned
- Meets or exceeds all industry requirements including UV, abrasion and Cal 117 standards for peace of mind
- Earth friendly fabric that can be recycled

100% Solution-Dyed Polyester **Awning Grade Collection**



5857 Sunrise



5838 Lemon



5806 Mandarin



5877 Circus Red



5803 Red



5836 Berry



5860 Vineyard



5850 Kiwi



5846 Forest Green



5856 Billiard



5816 Aqua



5801 Cobalt



5899 Regal



5839 Navy



5822 Khaki



5804 Eggshell



5851 Fog



5819 Boulder



5825 Mocha



5827 Chocolate



5870 Rosewood



5808 Black



A better world of outdoor fabrics™

TRULY A FRIEND TO THE GREAT OUTDOORS.

LIMITED QUANTITY:
Call for availability prior to placing order.



5815 Sunset



5853 Mineral



5861 Taupe



5842 Granite

100% Solution-Dyed Acrylic Furniture Grade Collection



5462HP Hot Pink



5639 Cannes Cabana Stripe*



5403 Jockey Red



6618 Bistro Red Stripe



6409 Terracotta



5407 Henna

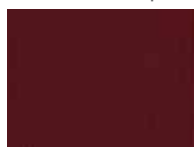

5436 Burgundy



5438 Buttercup



54011 Gingko



5446 Forest Green



6620 Bistro Green Stripe



6477 Turquoise



6617 Bistro Turquoise Stripe



6646 Paradise Seaglass Stripe*



5413 Spa



5420 Mineral Blue



5401 Pacific Blue



6433 Neptune



5604SB Sunset Beach Stripe*

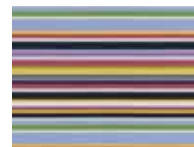

56064 Steeplechaise Malibu Stripe



5439 Navy



6457 Beacon Ash

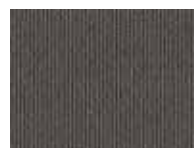

54048 Charcoal



6461 Taupe



5422 Antique Beige



5414 Wheat

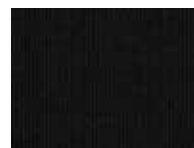

5408 Black



6619 Bistro Black Stripe



5470 Walnut



5432 Baybrown



5425 Cocoa



5453 Canvas



5404 Natural

Note: Fabric representation not to scale. Patterns, textures and colors may vary slightly from the actual fabric swatches.
STRIPED FABRICS: Must be ordered in pairs, due to cutting requirements.

shademaker™





bases & mount options



mounting options

Shademaker offers concrete, wood deck, and in-ground mount kits for most styles.

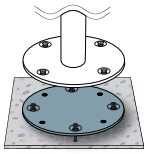

MKC21

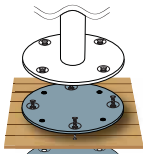

MKW21

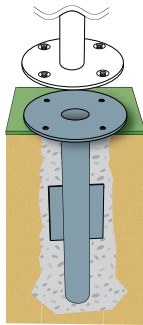

MKG21

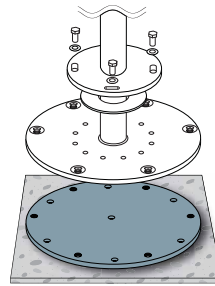

GMKC21

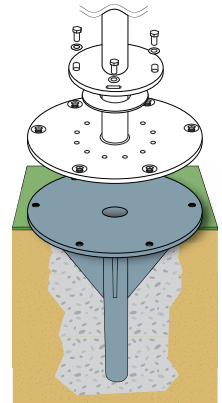

GMKG21

mount kits for corona, astral, sirius & orion

Item No.	Style	MSRP
MKC21	concrete mount kit	\$185
MKW21	wood deck mount kit	\$235
MKG21	in-ground mount kit	\$185

mount kits for galaxy

Item No.	Style	MSRP
GMKC21	concrete mount kit	\$265
GMKG21	in-ground mount kit	\$265

DISCLAIMER: The Shademaker™ mount kit should only be professionally installed by a licensed contractor duly qualified. Shademaker assumes no liability and expressly disclaims any responsibility for injuries or damages arising from or related to the failure of buyer to have the mount kit installed by a licensed professional contractor. Shademaker makes no warranty except as expressly stated herein, and no warranty except Title to Materials furnished shall be implied with respect to this order.

DISCLAIMER OF WARRANTIES: Except as herein expressly set forth, this product is sold "as is" and "with all faults", and without any implied warranty of merchantability -- which warranty is hereby expressly excluded. This product is sold without any implied warranty of fitness for a particular purpose -- which warranty is hereby expressly excluded. Moreover, there are no warranties which extend beyond the description on the face hereof.

steel bases

Solid steel base weights can be used with the **astral, corona, orion** and **sirius** styles. Square or round bases available to match a square or octagon canopy.

Refer to the **steel base combinations** (below) to meet recommended minimum weight requirements for each Shademaker™ style.

steel base (square)

Item No.	Weight	Size Thickness 5/8"	MSRP
SB50SQ*	50 lbs.	17"	\$135
SB100SQ**	100 lbs.	24"	\$265
SB125SQ	125 lbs.	27"	\$340

steel base (round)

Item No.	Weight	Size Thickness 5/8"	MSRP
SB50R	50 lbs.	17"	\$160
SB100R	100 lbs.	24"	\$315
SB125R	125 lbs.	27"	\$395

See pages **36-37** for more information on our heavy-duty steel bases.

***SB50SQ** 50 lb. square - to be used with the Hercules heavy-duty steel base.

****SB100SQ** 100 lb. square - to be used with the Zeus heavy-duty steel base.

steel base combinations



250 lbs.: (2) SB100SQ + (1) SB50SQ (shown)



250 lbs.: (2) SB100R + (1) SB50R (shown)

Total Weight	Basic steel base combinations	
	SQUARE	ROUND
150 lbs.	(1) SB100SQ + (1) SB50SQ	(1) SB100R + SB50R
250 lbs.	(2) SB100SQ + (1) SB50SQ	(2) SB100R + (1) SB50R
350 lbs.	(2) SB125SQ + (1) SB100SQ	(2) SB125R + (1) SB100R
400 lbs.	(2) SB125SQ + (1) SB100SQ + (1) SB50SQ	(2) SB125R + (1) SB100R + (1) SB50R

*See individual product pages
for recommended
minimum weight requirements.*

NEW

HEAVY-DUTY STEEL bases

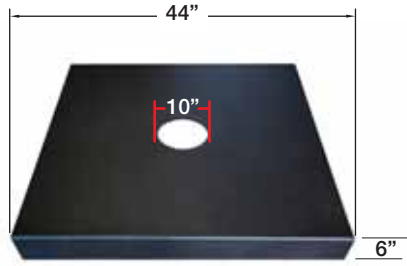

Features:

- Durable metalized steel/black powder coated cover
- Industrial grade steel frame
- Reinforced padded corners to protect surfaces
- Adjustable feet for leveling

hercules - a smaller version of the heavy-duty steel base available for **astral**, **orion** and **sirius** umbrella(s).

Custom order to mount (Twin Mount) 2 **orion** or **sirius** umbrellas.

We recommend a licensed contractor to secure your Shademaker™ umbrellas.

hercules heavy-duty steel base for astral, orion & sirius

Item No.	Style (includes)	Size	Weight	MSRP
H44449	Hercules (base frame/base cover) <i>base frame not shown</i>	44"	200 lbs.	\$3,200

custom configurations

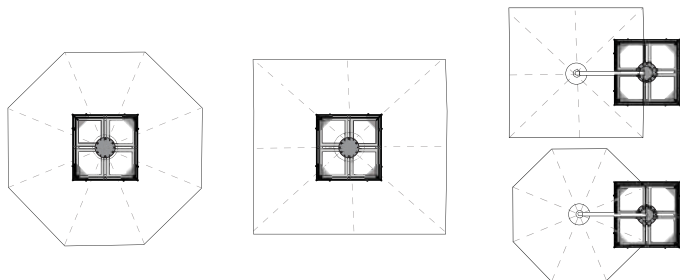

Center Mount

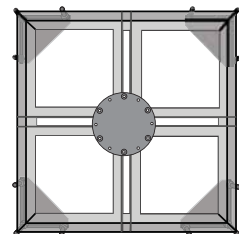

hercules (CENTER MOUNT)
fits all **astral**, **orion** and **sirius** styles

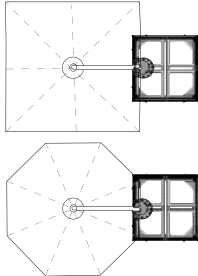

Offset Mount

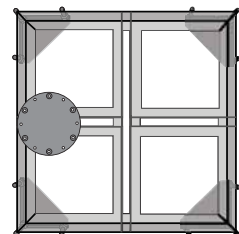

hercules (OFFSET MOUNT)
fits all **orion** and **sirius** styles

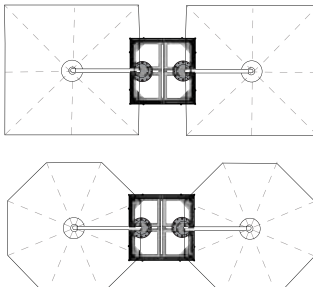

Twin Mount

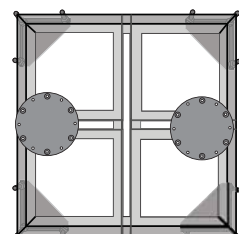

hercules (TWIN MOUNT)
fits all **orion** and **sirius** styles

ZEUS - our largest heavy-duty steel base which accommodates the **galaxy** and **orion (OR-30 or OR-35 only)** umbrella(s); perfect for rooftop and high wind installations.

Custom order to mount 1 or 2 **galaxy** umbrella(s) in various positions or mount 2, 3 or up to 4 **orion** umbrella(s) for maximum coverage.

**Sirius may also be mounted on our zeus base, however, the tilt feature will be limited.*

We recommend a licensed contractor to secure your Shademaker™ umbrellas.

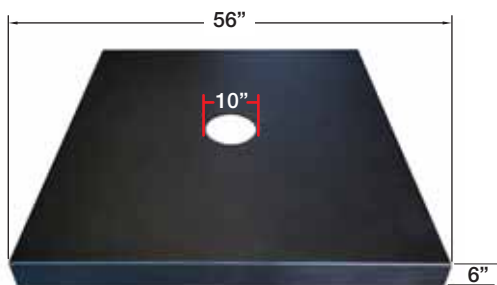

ZEUS heavy-duty steel base for orion & galaxy

Item No.	Style (includes)	Size	Weight	MSRP
Z56569	Zeus (base frame/base cover) base frame not shown	56"	225 lbs.	\$3,500

custom configurations

Corner Mount

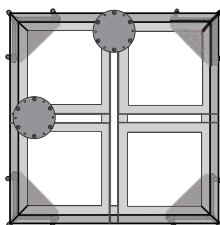
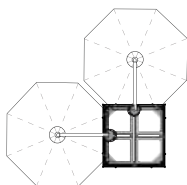

zeus (CORNER MOUNT)
fits orion (OR-30 or OR-35 only)*

Center Mount

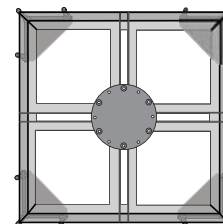
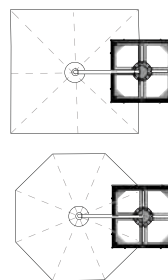

zeus (CENTER MOUNT)
fits all galaxy styles

Tri Mount

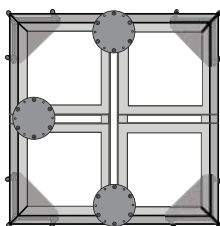
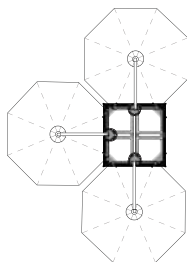

zeus (TRI MOUNT)
fits orion (OR-30 or OR-35 only)*

Twin Mount

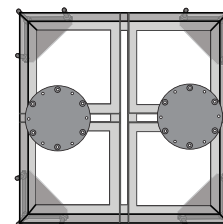
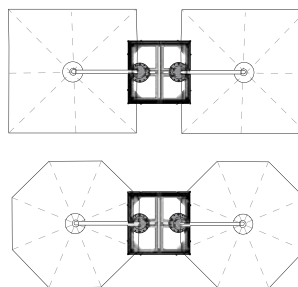

zeus (TWIN MOUNT)
fits all galaxy styles

Quad Mount

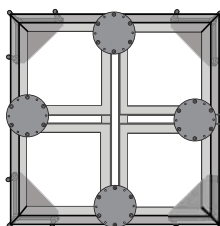
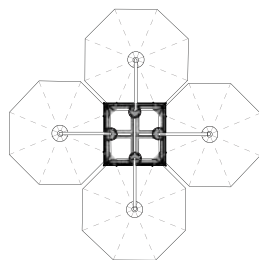

zeus (QUAD MOUNT)
fits orion (OR-30 or OR-35 only)*

NOTE: HEAVY-DUTY STEEL BASES: Sufficient base weight must be used to secure umbrellas at all times. Please see individual product pages for recommended minimum weight requirements for free-standing applications. Base weights sold separately.

MOUNTING: Mounting your umbrella to an existing deck or patio is always the preferred method of securing your umbrella above all other methods.

additional corona bases

steel base

Steel
w/casters

Item No.: **BSK1209**

Weight: 120 lbs.

MSRP: \$515

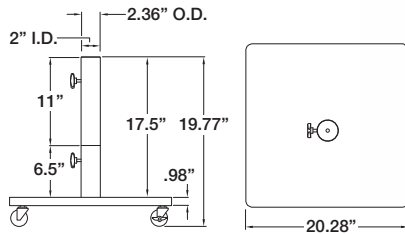

cast aluminum bases

Monaco
w/wheels & handle

Item No.:

Black **BKMSQ1009**

Silver **BKMSQ1005M2**

Weight: 100 lbs.

MSRP: \$495

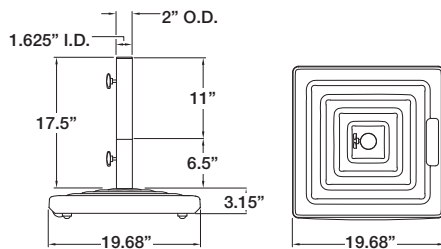

Monaco
w/wheels & handle

Item No.:

Black **BKM1009**

Silver **BKM1005M2**

Weight: 100 lbs.

MSRP: \$495

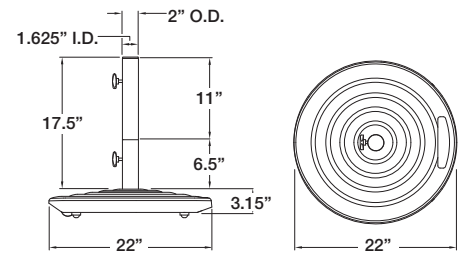

Add-On Weight

Item No.: **BW30**

Weight: 30 lbs.

MSRP: \$80

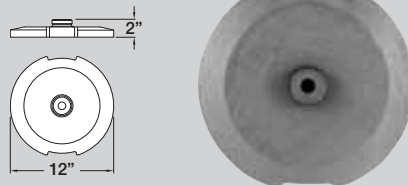

- Optional cast iron weight adds 30 lbs. to our cast aluminum base.

specifications

Item No.	Mast (round)	Wall Thickness	
		arms	mast
CORONA-20S	1 1/2"	1/16"	1/8"
CORONA-25S	1 1/2"	1/16"	1/8"
CORONA-25	1 1/2"	1/16"	1/8"
CORONA-30	1 1/2"	1/16"	1/8"

Item No.	Mast (oval)	Wall Thickness	
		arms	mast
SR-27S	2 3/4" x 4 3/8"	1/16"	1/8"
SR-30S	2 3/4" x 4 3/8"	1/16"	1/8"
SR-30	2 3/4" x 4 3/8"	1/16"	1/8"
SR-35	2 3/4" x 4 3/8"	1/16"	1/8"

Item No.	Mast (round)	Wall Thickness	
		arms	mast
ASTRAL-35S	3"	1/8"	1/4"
ASTRAL-40S	3"	1/8"	1/4"
ASTRAL-45	3"	1/8"	1/4"
ASTRAL-50	3"	1/8"	1/4"

Item No.	Mast (oval)	Wall Thickness	
		arms	mast
OR-27S	2 3/4" x 4 3/8"	1/16"	1/8"
OR-30S	2 3/4" x 4 3/8"	1/16"	1/8"
OR-30	2 3/4" x 4 3/8"	1/16"	1/8"
OR-35	2 3/4" x 4 3/8"	1/16"	1/8"
OR-40	2 3/4" x 4 3/8"	1/16"	1/8"

Item No.	Mast	Arm Wall Thickness
NV-27S	n/a	1/16"

Item No.	Mast (oval)	Wall Thickness	
		arms	mast
GALAXY-35S	3 1/4" x 4 3/4"	1/8"	1/4"
GALAXY-40S	3 1/4" x 4 3/4"	1/8"	1/4"
GALAXY-50	3 1/4" x 4 3/4"	1/8"	1/4"

Visit www.shademakerusa.com for more details on sizes and specifications.

options

Canopy Cover	Application	MSRP
Protective Cover	orion, sirius, nova & corona	\$85
	astral & galaxy	\$125

Fabric	Price
Glen Raven Firesist®	Price Group 1 (+ 25%)

FIREISIST® awning fabric combines state-of-the-art flame retardant performance and UV resistance for the commercial awning, canopy and shade markets.

Specialty Canopy	Application	MSRP
Valance	orion, sirius, nova & corona	\$80
	astral & galaxy	\$160
	astral (5.0m) & galaxy (5.0m)	\$200

maintenance

maintaining the shademaker frame & fittings

1. Hose mast and frame with water periodically, more often if installation is in a salty or industrial environment.
2. Inspect the installation fitting, mount bolts, rib spacers, etc. on a regular basis and tighten if necessary.
3. Lubricate the track and slider car mechanism as needed to enhance the ease of operation. *We recommend using DuPont™ Dry Film Lubrication Products.*

maintaining the shademaker canopy fabric

1. Clean up spills and stains right away. Spills can be removed by using a clean absorbent cloth.
2. For general maintenance, use a soft brush to remove dust and dry soil. Wash down with clean, warm water (i.e.: garden hose) every so often to avoid dirt becoming engrained. Allow the fabric to air dry before closing the canopy.
3. If a thorough cleaning is necessary, sponge over the fabric using a mild soap solution (2% solution). Rinse well with plenty of water to remove all soap residues.
4. **Never use detergents, cleaning fluids or solvents. Grease and oil stains may be removed by using turpentine or similar with an absorbent cloth.**
5. We recommend giving the canopy a good cleaning on a more frequent basis if installed in a location where the canopy is likely to become soiled.
6. Please visit the fabric websites for more details: www.obravia.com or www.sunbrella.com
7. Use protective canopy cover during storage or when not in use.

general guidelines

1. While Shademaker umbrellas are made to withstand some wind – it is recommended that the umbrellas always be lowered during windy conditions. If it is too windy to enjoy your umbrella, then the umbrella should be closed. Please remove the umbrella during extreme weather conditions to avoid damage that could be caused by flying debris.
2. **NOTE: Wind damage (or any damage caused by acts of nature) is not covered under warranty.**
3. Sufficient base weight must be used to secure umbrellas at all times. Please see individual product pages for recommended minimum weight requirements for free-standing applications. Mounting your umbrella to an existing deck or patio is always the preferred method of securing your umbrella above all other methods. We recommend a licensed contractor to secure your Shademaker umbrellas.

warranty

Shademaker™ manufactures all its shade styles from the finest aluminum alloys to ensure the strength, durability, and integrity of each and every style. We pride ourselves as a totally vertical operation. This means that we manufacture and produce over 90% of the components used in our products from the raw state. We can monitor every stage of the manufacturing process and maintain a consistent level of quality.

Our only business and focus is shade and shade type products. Our goal is that each and every Shademaker style will exceed your expectations at a competitive price that will make you smile.

Our Limited Warranty is outlined below by individual styles. NOTE: **Wind damage is not covered** under any manufacturer's warranty.

Our umbrellas are serviceable, meaning that parts can be ordered under warranty at no charge, if found that the damage is a manufacture defect and/or purchased out of warranty to make them whole again.

10 Year Limited Warranty includes the GALAXY, ORION and ASTRAL styles. This includes the mast, boom, head fitting, elbow, center pole, top and bottom hub, and stainless steel hardware only. If there is damage under the warranty, Shademaker will replace and/or repair any item listed in this category at its discretion. Labor charges are not covered under this limited warranty.

10 Year Limited Warranty includes the Sunbrella® awning & marine grade Fabric Collection. Visit www.sunbrella.com/warranty for more details. Labor charges are not covered under this limited warranty.

5 Year Limited Warranty includes the SIRIUS, CORONA and NOVA styles. This includes the mast, arms, ribs, center pole, top and bottom hubs, and stainless steel hardware only. If there is damage under the warranty, Shademaker will replace and/or repair any item listed in this category at its discretion. Labor charges are not covered under this limited warranty.

The **5 Year Limited Warranty** also applies to Sunbrella Firesist®, Sunbrella Firesist® PLUS and Sunbrella® furniture grade, and O'bravia™ awning grade fabrics. Labor charges are not covered under this limited warranty. Visit www.sunbrella.com/warranty for more details and www.obravia.com for more details. Labor charges are not covered under this limited warranty.

1 Year Limited Warranty covers the powder coat finish on all bases. If the powder coat finish flakes, bubbles, peels or loses color; Shademaker will re-finish or replace the defective bases at its discretion. Normal wear and tear is not covered under this limited warranty. Labor charges are not covered under this limited warranty.

Exclusions: Wind damage, acts of nature (such as, but not limited to, freezing or any type of extreme weather). Failures caused by abusive use and normal wear and tear are not covered under this warranty.

Those filling warranty claims will be responsible for all shipping, handling, and freight charges on all claims to Shademaker in Baldwin Park, CA. All warranty claims must be submitted with the original proof of purchase, date of purchase, name of dealer, and the description of the damage. The Shademaker warranty is not transferable. Shademaker reserves the right to repair, replace, and/or redesign any product that is returned under a warranty claim.

shademaker
13401 Brooks Drive
Baldwin Park, CA 91706

p 626 338 8810 f 626 338 8816
shademakerusa.com
info@shademakerusa.com

CHICAGO SHOWROOM
1655 Merchandise Mart
Chicago, IL 60654

shademaker™

shademaker™

13401 Brooks Drive
Baldwin Park, CA 91706

p 626 338 8810 f 626 338 8816
info@shademakerusa.com

CHICAGO SHOWROOM
1655 Merchandise Mart
Chicago, IL 60654



shademakerusa.com

SM-CAT-813
©2013 Shademaker.
All Rights Reserved.